

SK-42C04 

SK-42C14 

Rating : 0.3A 50V DC

Function: 4P2T

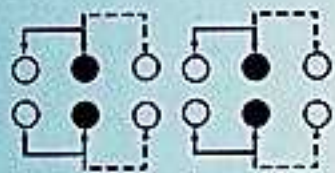

Optional knob type

GEE	VAC				

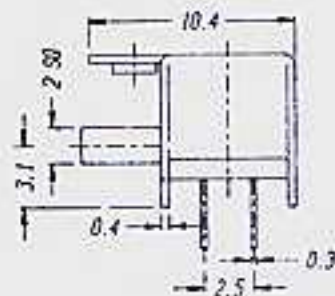
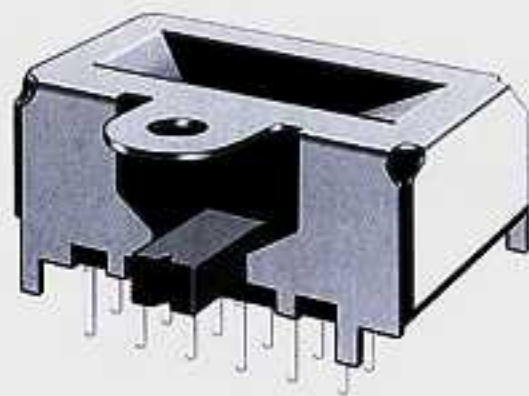
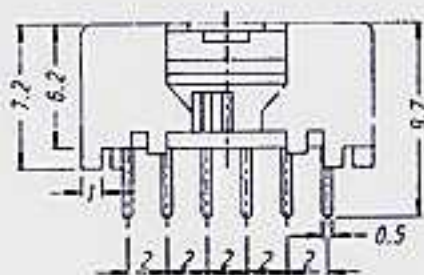
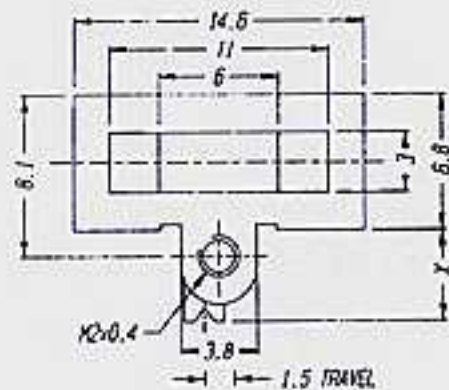

# SK-42H04

Rating : 0.3A 50V DC

Function: 4P2T

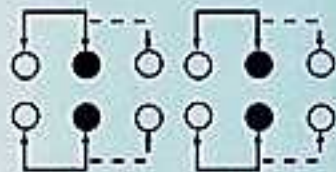

Optional knob type

GDI	GDB	GDA	MXD		

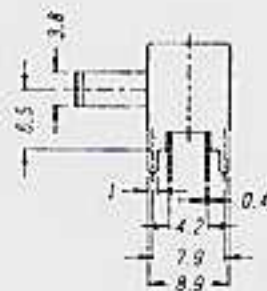
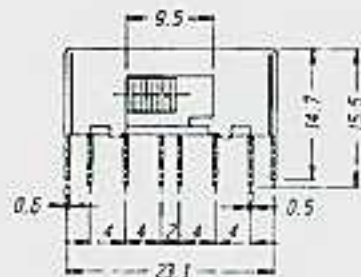
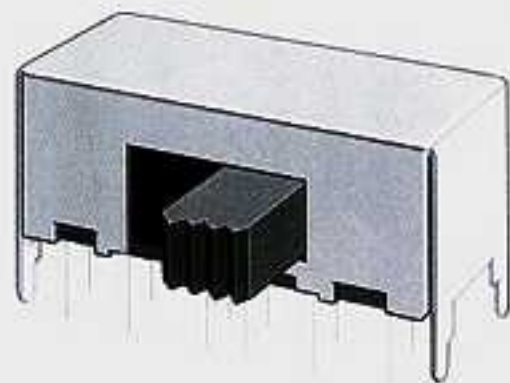
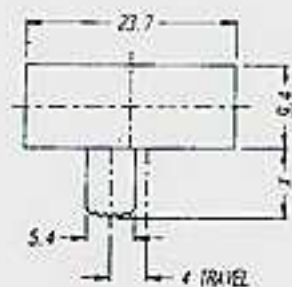

# SK-42H03 (L1R3)

Rating : 0.3A 50V DC

Function: 4P2T



Optional knob type



GDI	GDB	GDM	MXD		

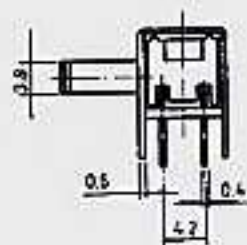
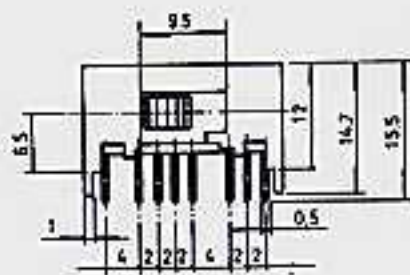
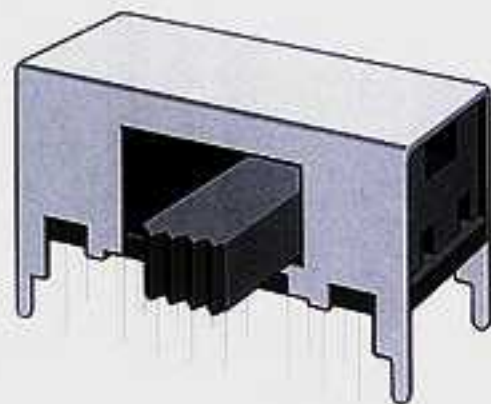
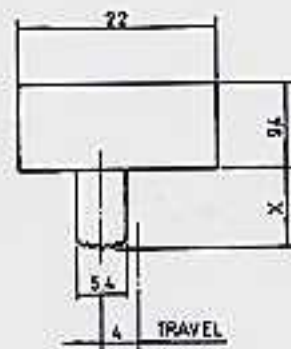

# SK-42H01 (L1R3)

Rating : 0.3A 50V DC

Function: 4P2T

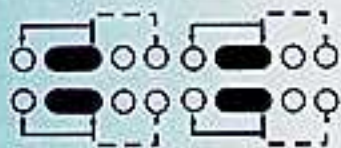

Optional knob type



GDI	GDB	GDM	MXD		

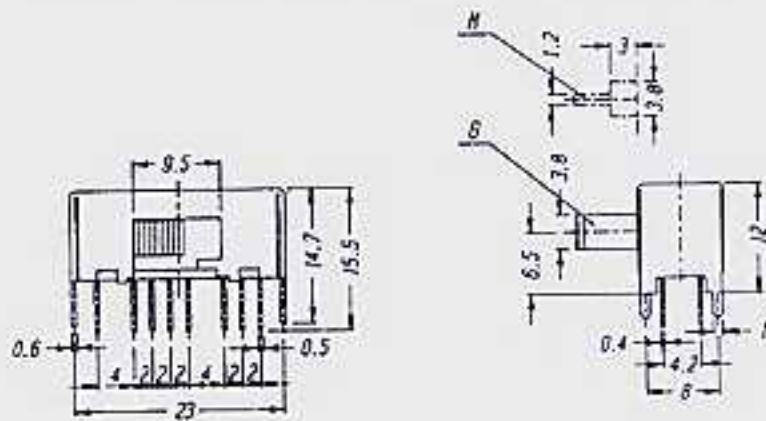
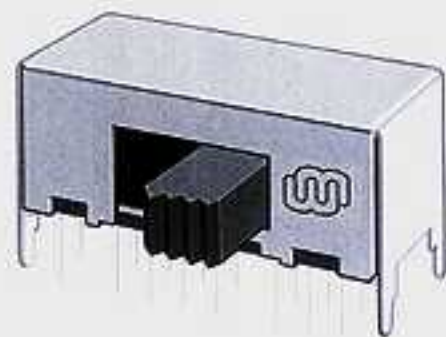
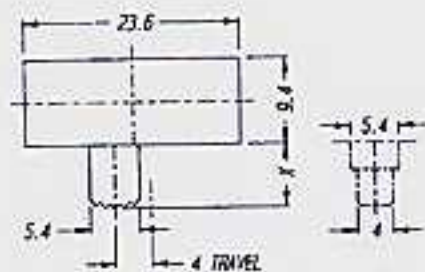

# SK-42F02

Rating : 0.3A 50V DC

Function: 4P2T

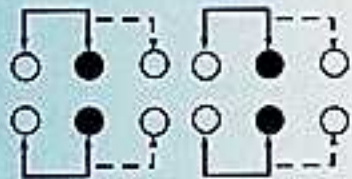

Optional knob type



ATA	MXC	GDI			

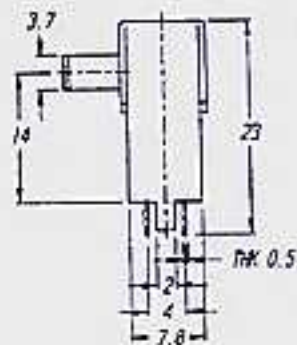
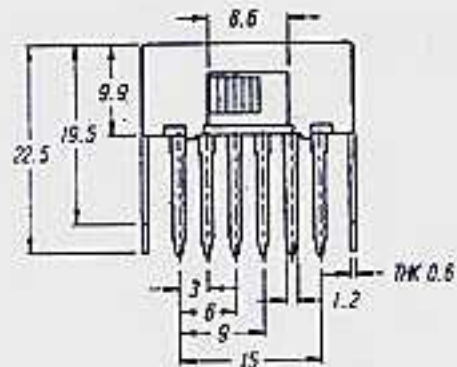
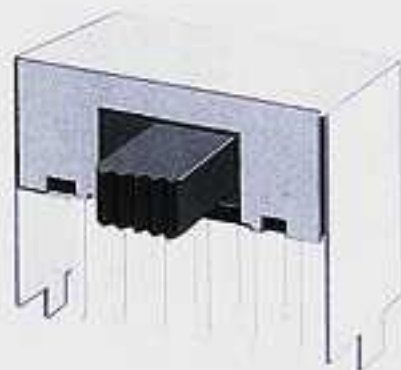
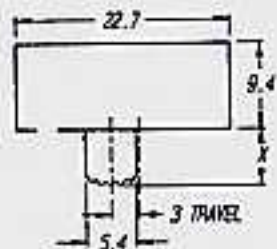

# SK-42F01

Rating : 0.3A 50V DC

Function: 4P2T

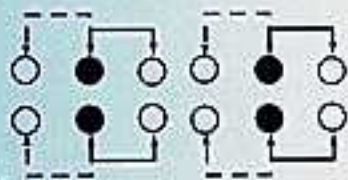

Optional knob type



ATA	MXC	GDI			

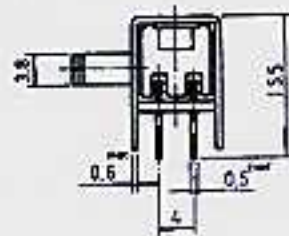
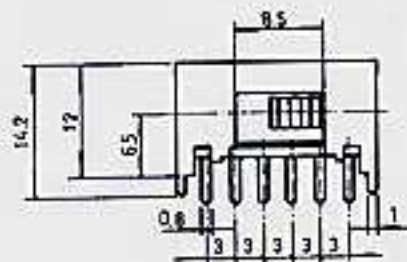
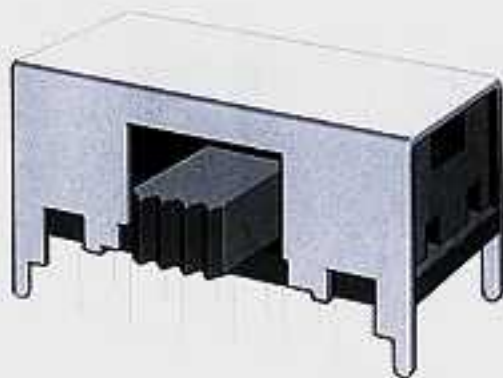
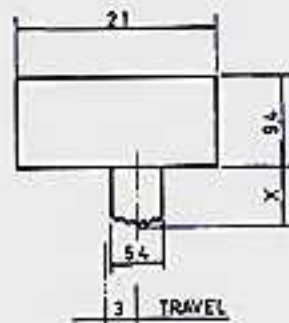

# SK-42D15

Rating : 0.3A 50V DC

Function: 4P2T

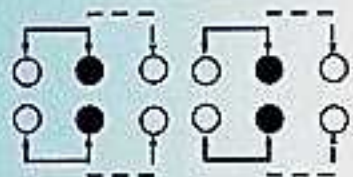

Optional knob type



TAF					

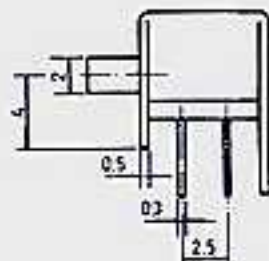
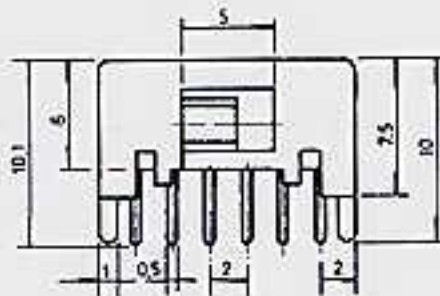
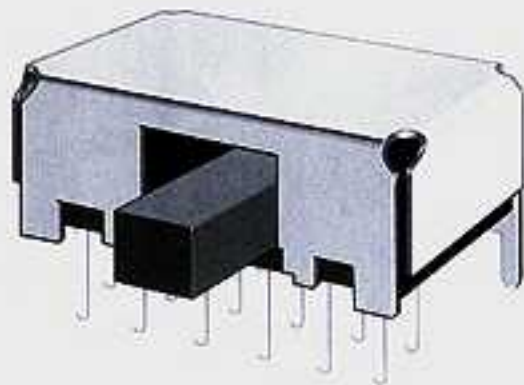
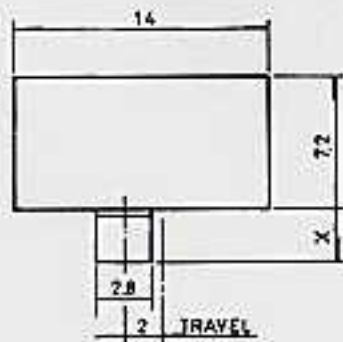

# SK-42D05

Rating : 0.3A 50V DC

Function: 4P2T

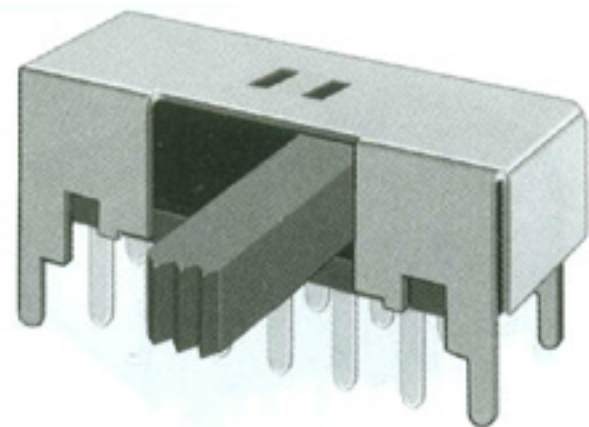
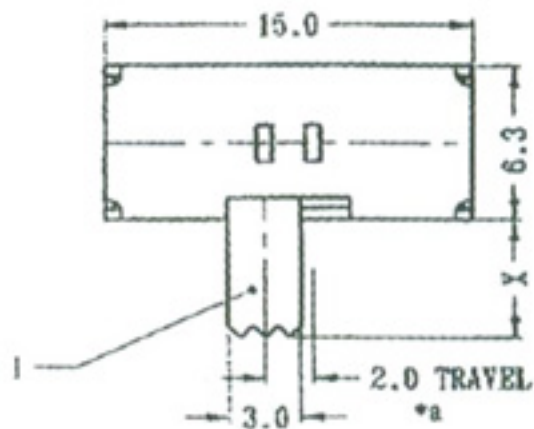
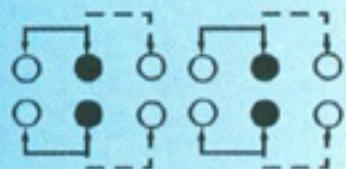

Optional knob type



GEE	VAC				

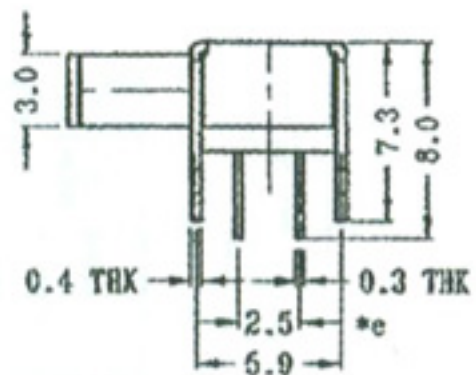
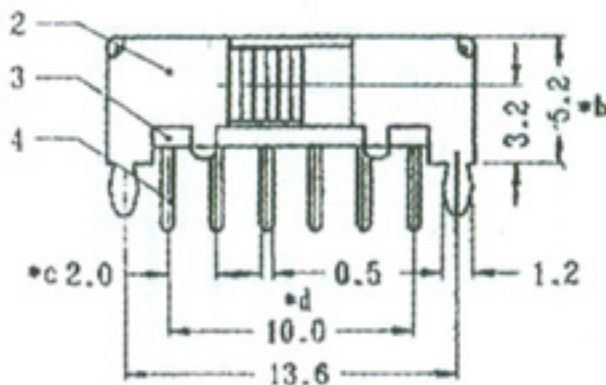



# SK-42D03

Rating : 0.3A 50V DC

Function: 4P2T

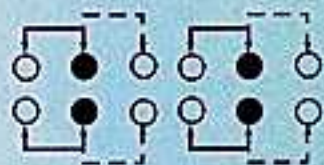

N

Optional knob type

GEE	VAC				

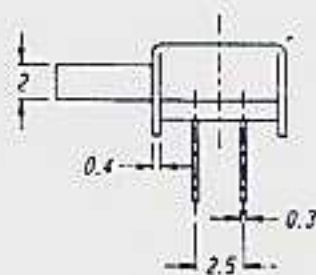
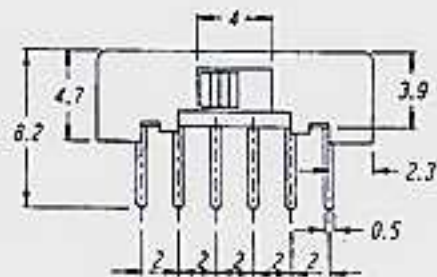
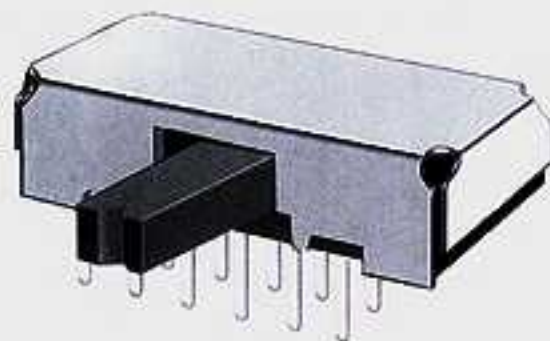
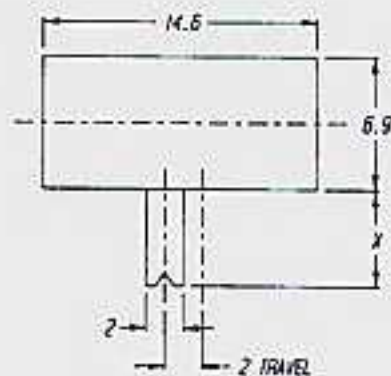

# SK-42D02

Rating : 0.3A 50V DC

Function: 4P2T

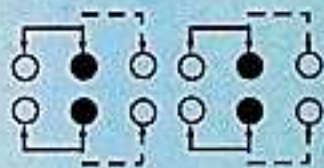

Optional knob type

GEE	VAC				

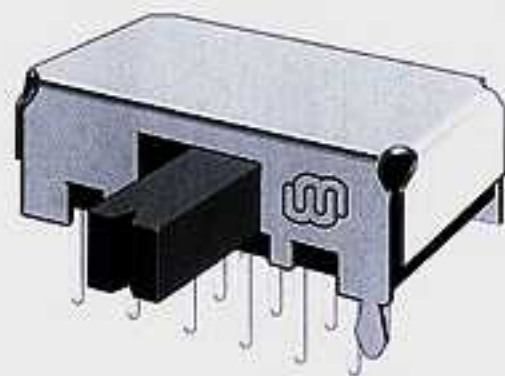
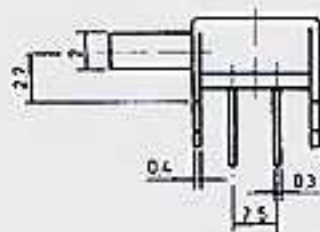
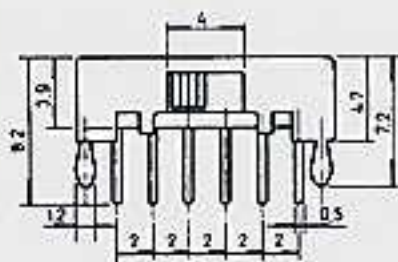
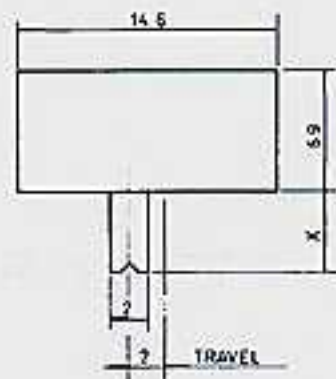

# SK-42D01

Rating : 0.3A 50V DC

Function: 4P2T

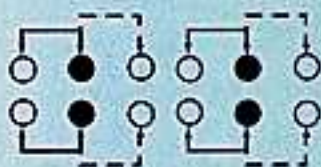

Optional knob type

PGA	VAA				

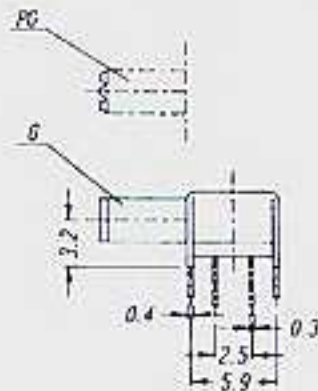
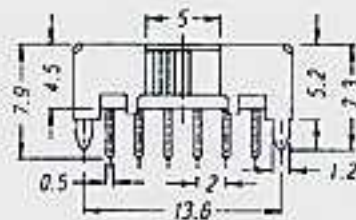
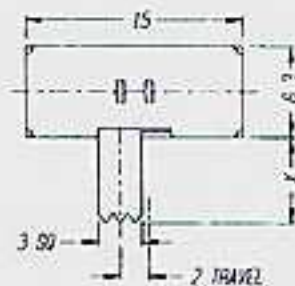
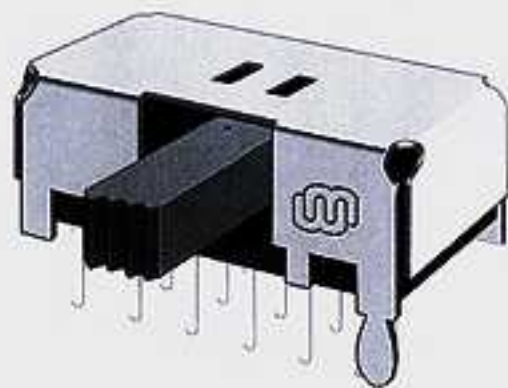

SK-42C09 

SK-42C19 

Rating : 0.3A 50V DC

Function: 4P2T

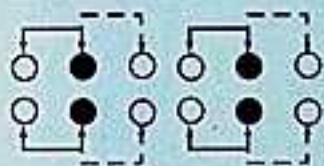

Optional knob type

GEE	VAC				

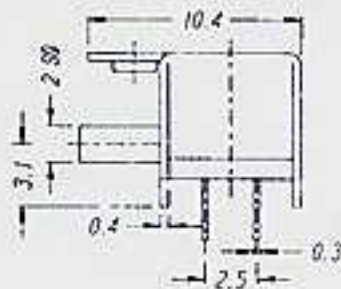
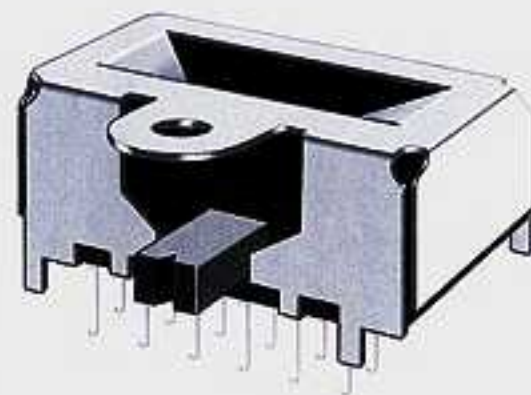
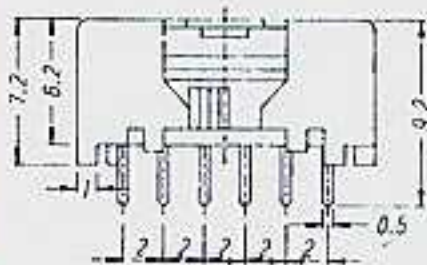
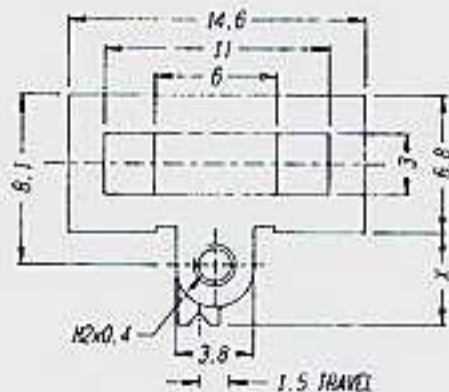

SK-42C07 

SK-42C17 

Rating : 0.3A 50V DC

Function: 4P2T

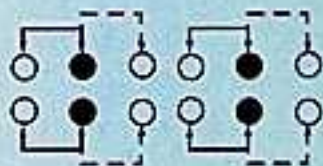

Optional knob type

GEE	VAC				

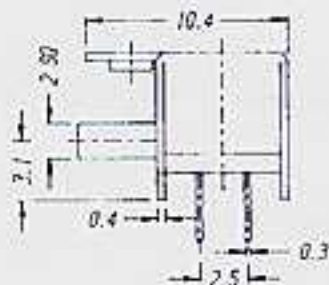
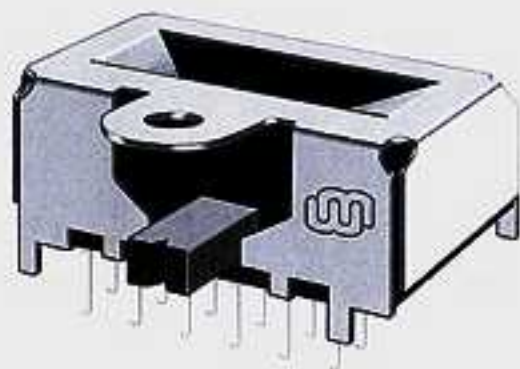
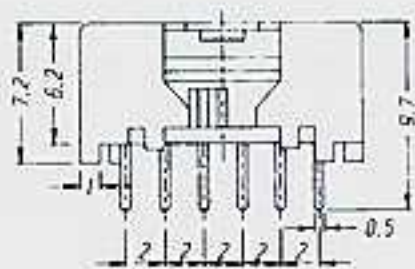
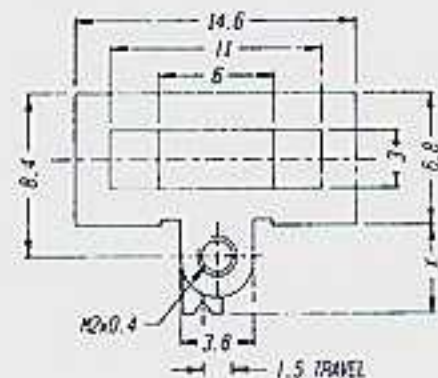

SK-42C06 

SK-42C16 

Rating : 0.3A 50V DC

Function: 4P2T

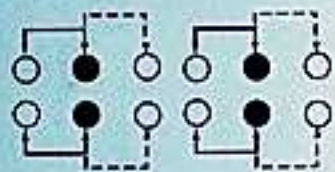

Optional knob type

GEE	VAC				

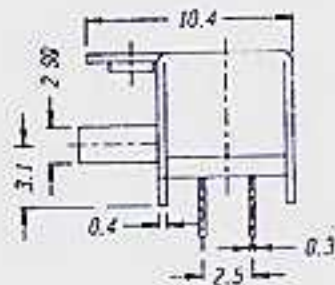
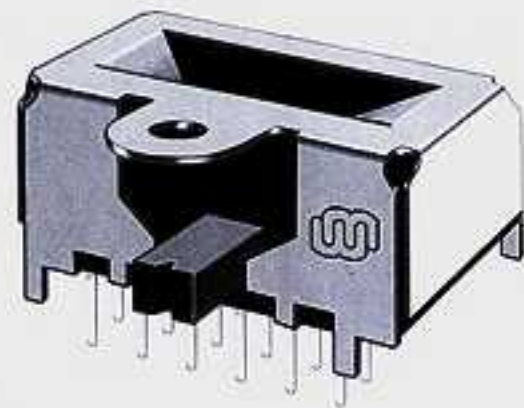
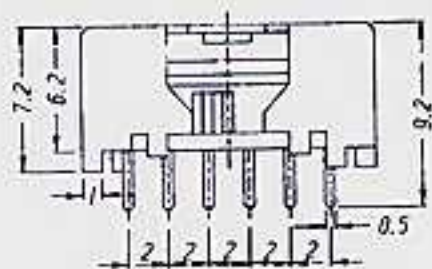
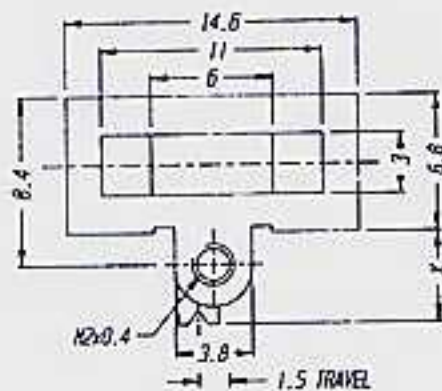

# SK-42H13

Rating : 0.3A 50V DC

Function: 4P2T

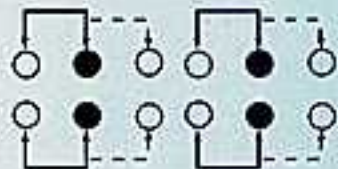

Optional knob type

GDI	GDB	GDA	MXD		

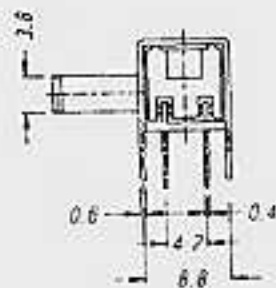
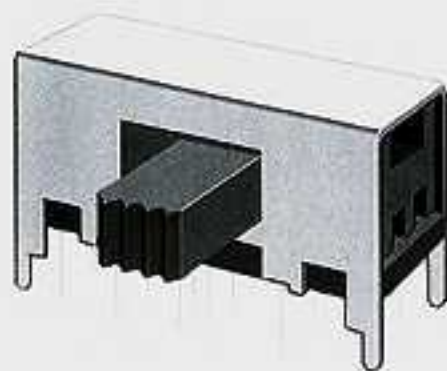
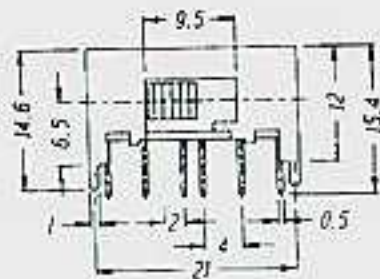
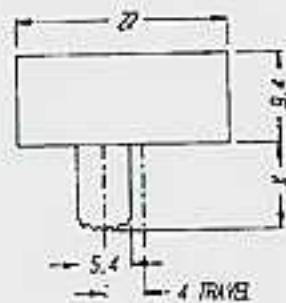

# SK-43F01

Rating : 0.3A 50V DC

Function: 4P3T

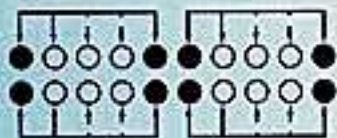

Optional knob type



GBG					

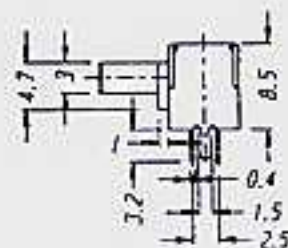
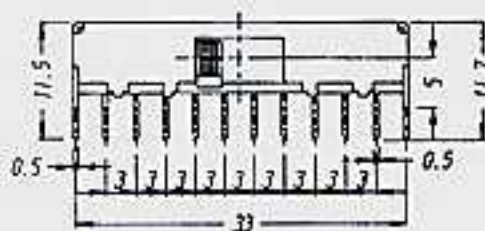
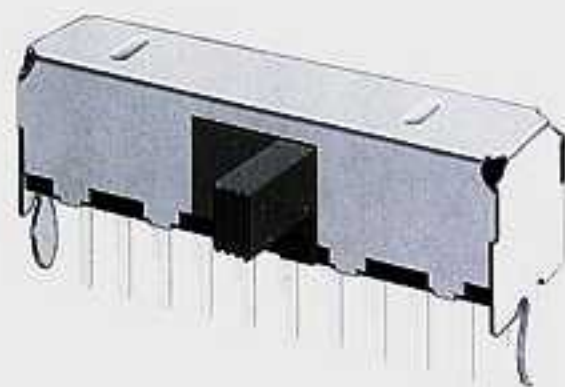
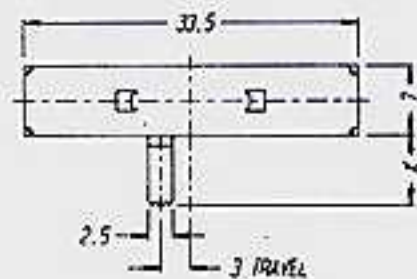



# SK-43D14(L1R3)

Rating : 0.3A 50V DC

Function: 4P3T

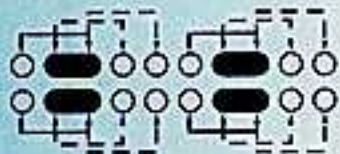

Optional knob type



GEH					

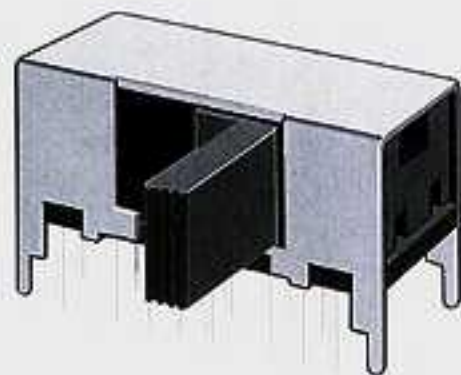
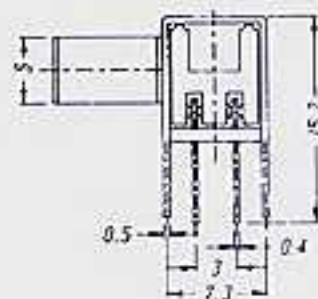
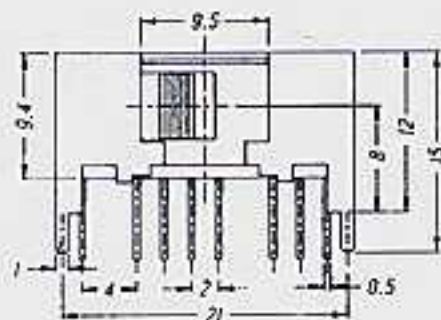
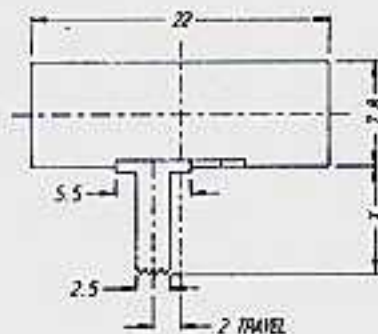

# SK-43D11 (L1R3)

Rating : 0.3A 50V DC

Function: 4P3T

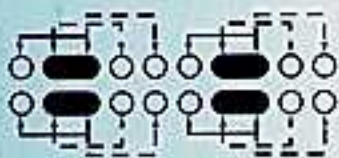

Optional knob type



GDI	GDB	GDM	MXD		

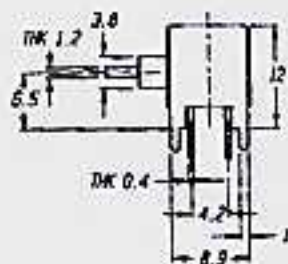
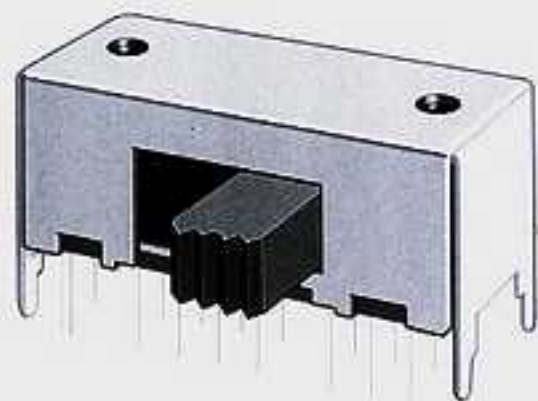
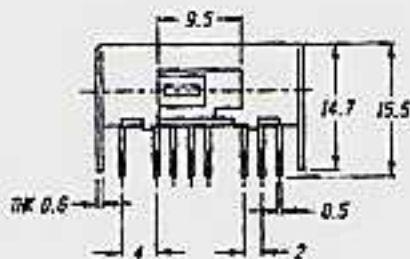
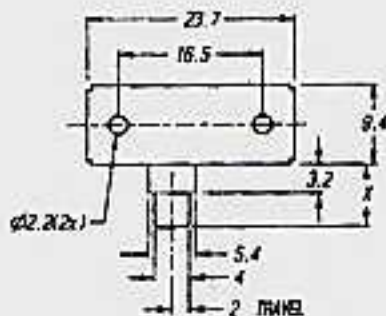

**SK-43D09** (L3R1)

**SK-43D10** (L1R3)

Rating : 0.3A 50V DC

Function: 4P3T

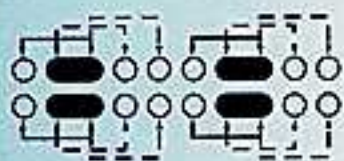

Optional knob type



TAF	PGA				

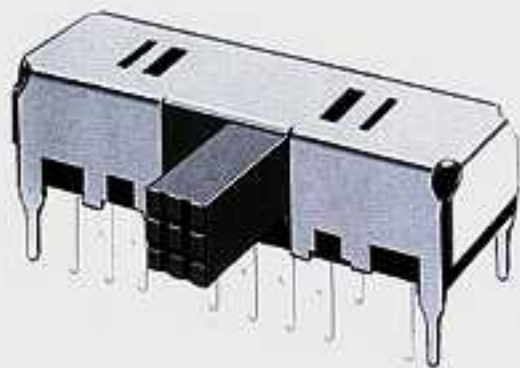
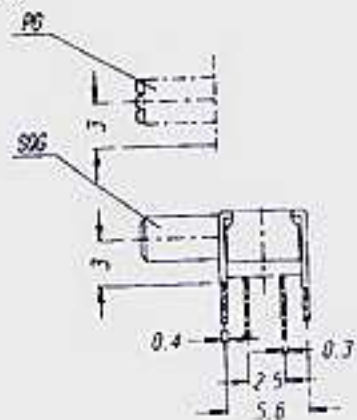
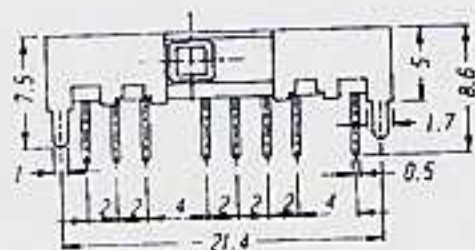
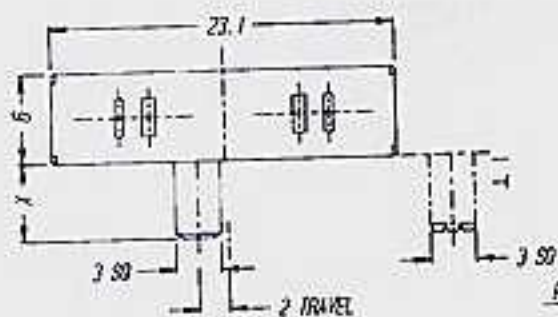

# SK-43D08(L3R1)

Rating : 0.3A 50V DC

Function: 4P3T

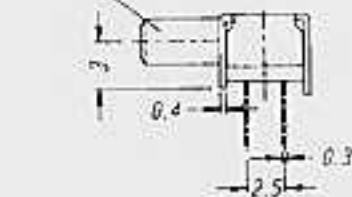
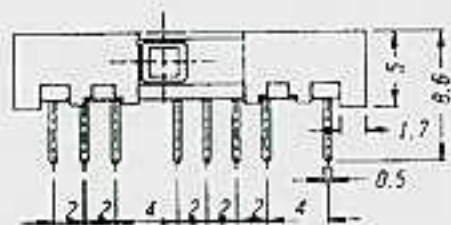
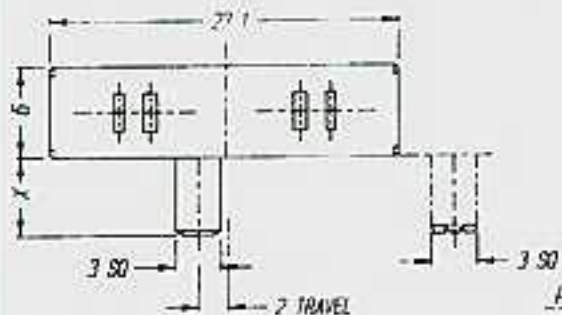
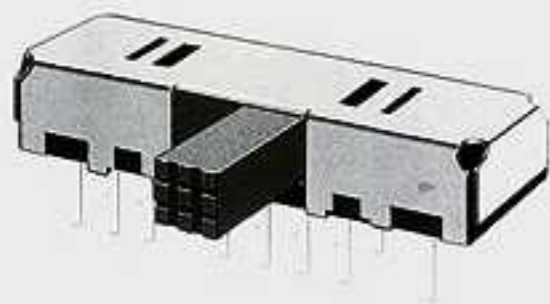
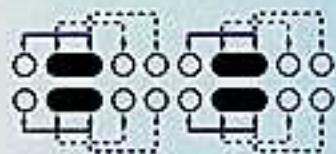

Optional knob type

TAZ	PGA				

# SK-43D03(L1R3)

Rating : 0.3A 50V DC

Function: 4P3T

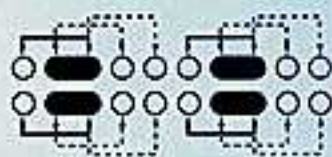

Optional knob type

GDI	GDB	GDA	MXD		

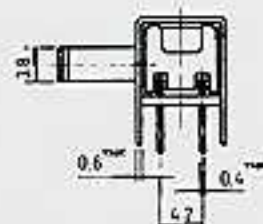
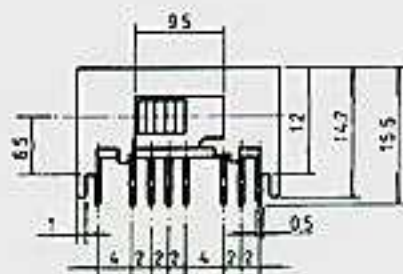
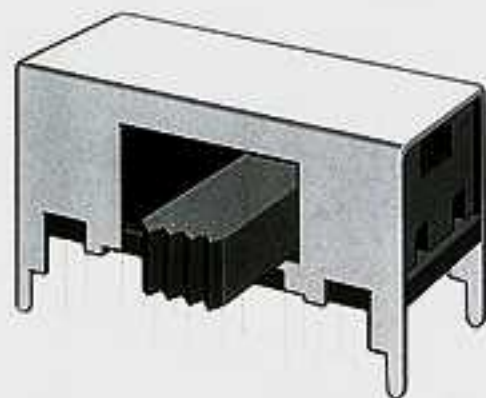
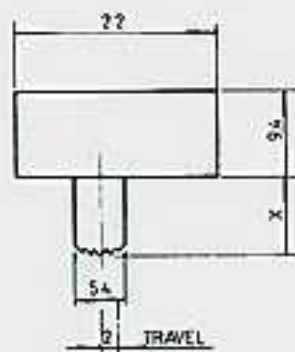

# SK-43D01 (L1R3)

Rating : 0.3A 50V DC

Function: 4P3T

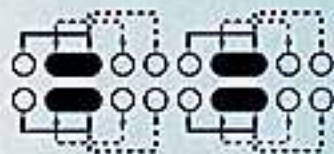

Optional knob type

GDI	GDB	GDA	MXD		

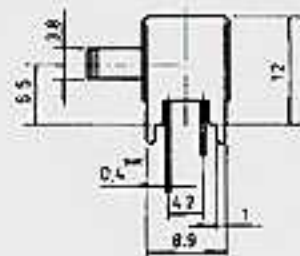
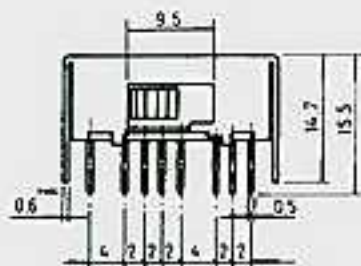
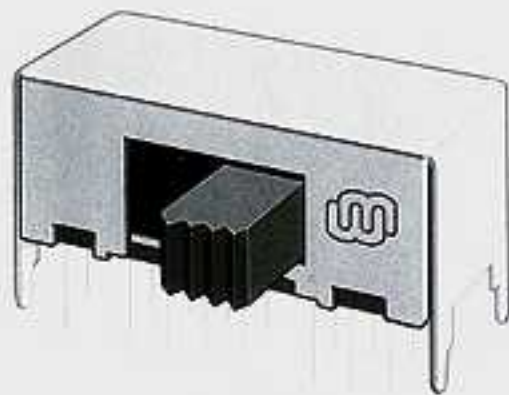
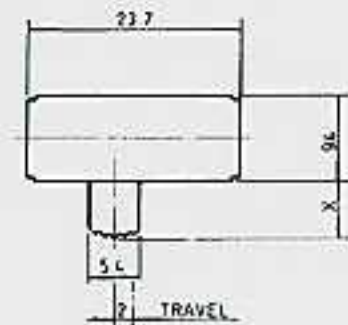

# SK-44F01

Rating : 0.3A 50V DC

Function: 4P4T

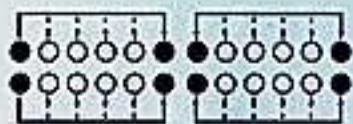

Optional knob type

GEG					

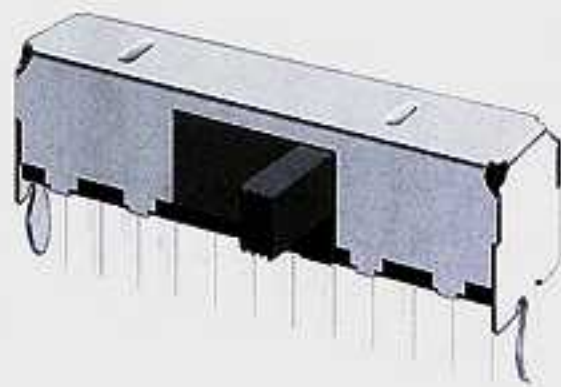
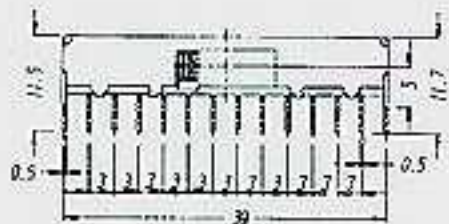
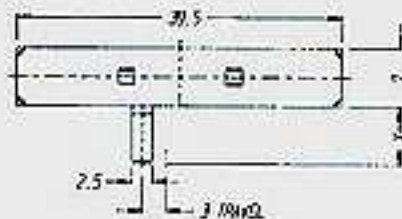
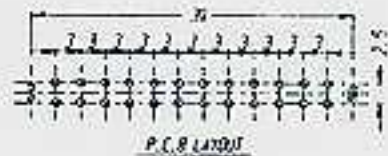

# SK-44D01 (L3R2)

Rating : 0.3A 50V DC

Function: 4P4T

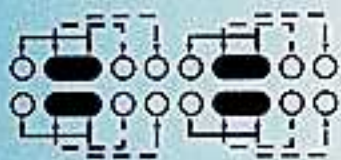

Optional knob type



MXF	GDD	GDG			

